



**SPECIFICATION SHEET**

<b>SPECIFICATION SHEET NO.</b>	N0723- CR0201PM0RS001
<b>DATE</b>	July 23, 2021
<b>REVISION</b>	A0
<b>DESCRIPTION</b>	Thick Film Chip Resistors, 0201 (0603 Metric) Series, L0.60*W0.30*H0.23mm, <i>Tolerance: Jumper, Resistance 0 ohm, Dissipation 1/20W Max.</i> Operating Temp. Range -55°C ~+125°C Package in Tape/Reel, 15,000pcs/Reel RoHS/RoHS III compliant
<b>CUSTOMER</b>	
<b>CUSTOMER PART NUMBER</b>	
<b>CROSS REF. PART NUMBER</b>	
<b>ORIGINAL PART NUMBER</b>	Aillen CR01PM0R
<b>PART CODE</b>	CR0201PM0RS001

<b>VENDOR APPROVE</b>			
Issued/Checked/Approved			
DATE: July 23, 2021			

<b>CUSTOMER APPROVE</b>	
DATE:	

**THICK FILM CHIP RESISTORS 0201 SERIES**

**MAIN FEATURE**

- High Reliability And Stability
- Reduced Size Of Final Equipment
- Lower Assembly Costs
- Higher Component And Equipment Reliability
- RoHS III Compliant And Halogen Free Products

**APPLICATION**

- Consumer Electrical Equipment
- EDP, Computer Application
- Telecom Application

**RFQ**  
Request For Quotation

**PART CODE GUIDE**

CR	0201	P	M	OR	S	001
1	2	3	4	5	6	7

- 1) **CR**: Product code for Thick Film Chip Resistors
- 2) **0201**: Series Code, 0201 (0603 Metric) Series, Dimensions L0.60\*W0.30\*H0.23mm,
- 3) **P**: Resistance Range Tolerance Code, P: Jumper; B: +/-0.1%; D: +/-0.5%; F: +/-1%; J: +/-5%
- 4) **M**: Package Code, A: 4Kpcs/Reel; B: 5kpcs/Reel; C: 10kpcs/Reel; M: 15kpcs/Reel; D: 10kpcs/10" Reel; E: 20kpcs/10" Reel
- 5) **OR**: Resistance value code. **OR: Ohm**; 1R2: 1.2ohm; 15R: 15ohm; 20R: 20ohm; 51R: 51ohm; 240R: 240ohm; 390R: 390 ohm; 1K: 1Kohm; 10K: 10Kohm; 15K: 15 Kohm;10K5: 10.5Kohm; 1K21: 1.21 Kohm; 100K: 100Kohm; 226K: 226Kohm; 1M: 1.0Mohm; 1M2: 1.2Mohm
- 6) **S**: SMD type code
- 7) **001**: Internal control code, 1~3 digits or letter; Blank: N/A

**THICK FILM CHIP RESISTORS 0201 SERIES**

**DIMENSION (Unit: mm)**

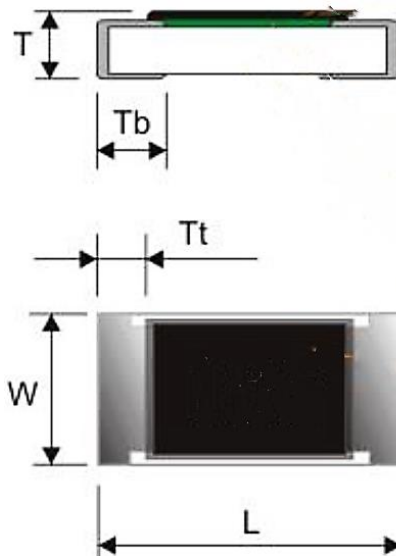

Image for reference



**General Marking:**  
Blank

0201



Item	Dimension
L	0.60±0.03
W	0.30±0.03
T	0.23±0.03
T b	0.15±0.05
T t	0.10±0.05

**Resistors Construction For Reference**

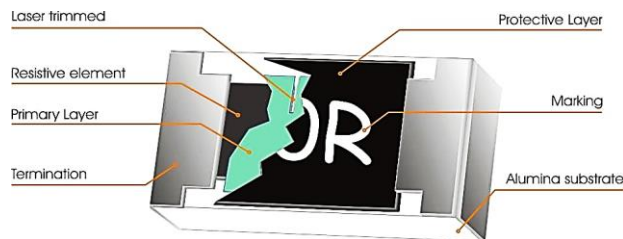

**Recommended Solder Pad**

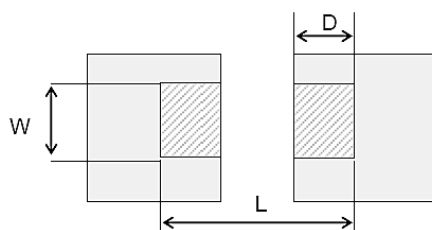

Item	Dimension
W	0.25~0.30
L	0.70~0.90
D	0.30~0.40

**THICK FILM CHIP RESISTORS 0201 SERIES**
**GENERAL ELECTRONICAL CHARACTERISTICS**

Item		Unit	Symbol	Characteristic	Condition
Product Name			CR	Thick Film Chip Resistors	
Size			0201	0201 (0603 Metric) Series, Dimensions L0.60*W0.30*H0.23mm	
Resistance Range		Ω		0	
Resistance Tolerance		%	J	Jumper	
TCR	10Ω~100MΩ	ppm/°C		≤±200	
	1Ω~9.76Ω			-200~+600	
Max. Dissipation		W		1/20	@ Tamb=70°C
Operating Temperature		°C		-55 ~+125	
Max. Operation Voltage		V		25	@DC or RMS
Max. Overload Voltage		V		50	@DC or RMS

**TEST CONDITION FOR JUMPER (0 Ω)**

Item		Unit	Symbol	Characteristic	Condition
Power Rating At 70°C		W		1/20	
Max. Resistance		mΩ		50	
Rated Current		A		1.0	
Peak Current		A		2.5	
Operating Temperature		°C		-55 ~+125	

**Note**

- 1) This is the maximum voltage that may be continuously supplied to the resistor element, see "IEC publication 60115-8"
- 2) Max. Operation Voltage : So called RCWV (Rated Continuous Working Voltage) is determined by

$$RCWV = \sqrt{\text{Rated Power} \times \text{Resistance Value}} \text{ or Max. RCWV listed above, whichever is lower.}$$

**THICK FILM CHIP RESISTORS 0201 SERIES**

**GENERAL CHARACTERIZATION**

Standard values of nominal resistance are taken from the E24 & E96 series for resistors with a tolerance of +/-0.1%, +/-0.50, +/-1%, +/-5%, The values of the E24/E96 series are in accordance with "IEC publication 60063"

Derating: The power that the resistor can dissipate depends on the operating temperature; see Fig.1

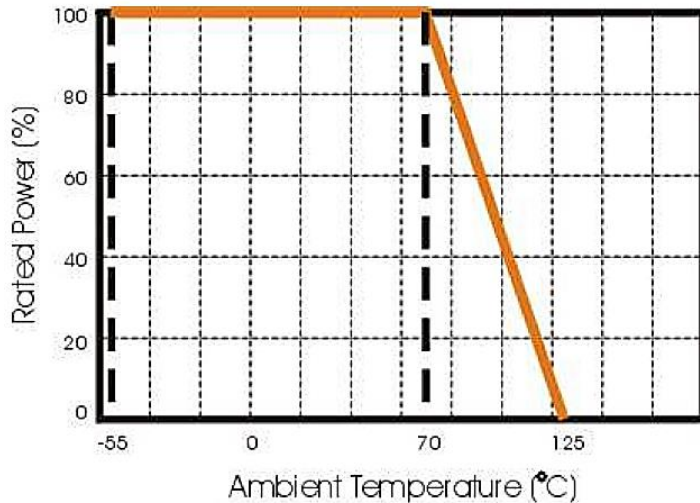

Fig 1 Maximum dissipation in percentage of rated power as a function of the ambient temperature for CR0402

**STORAGE AND HANDLING CONDITIONS**

1) Products are recommended to be used up within two years since operation date as ensured shelf life.

Check solderability in case shelf life extension is needed.

2) To store products with following condition: Temperature : 5 to 40°C Humidity: 20 to 70% relative humidity

3) Don't store products in a corrosive environment such as sulfide, chloride gas, or acid. It may cause oxidization of electrode, which easily be resulted in poor soldering b.To store products on the shelf and avoid exposure to moisture. Don't expose products to excessive shock, vibration, direct sunlight and so on.

**THICK FILM CHIP RESISTORS 0201 SERIES**

**REFLOW SOLDERING CONDITION**

The robust construction of chip resistors allows them to be completely immersed in a solder bath of 260 °C for 10 seconds. Therefore, it is possible to mount Surface Mount Resistors on one side of a PCB and other discrete components on the reverse (mixed PCBs). Surface Mount Resistors are tested for solderability at 235 °C during 2 seconds. The test condition for no leaching is 260°C for 30 seconds. Typical examples of soldering processes that provide reliable joints without any damage are given in Fig 2.

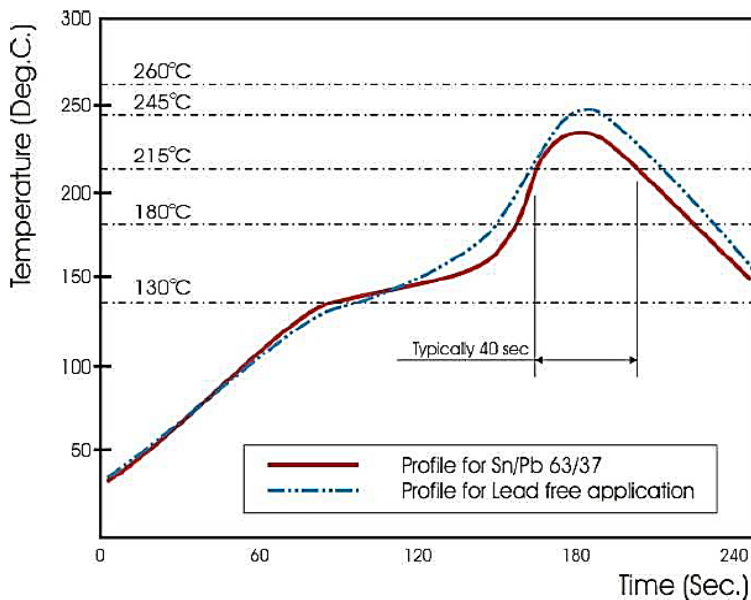

Fig 2. Infrared soldering profile for Chip Resistors

**TEST AND REQUIREMENTS**

Essentially all tests are carried out according to the schedule of IEC publication 115-8, category **LCT/UCT/56**(rated temperature range: Lower Category Temperature, Upper Category Temperature; damp heat, long term, 56 days). The testing also meets the requirements specified by EIA, EIAJ and JIS. The tests are carried out in accordance with IEC publication 68, "Recommended basic climatic and mechanical robustness testing procedure for electronic components" and under standard atmospheric conditions according to IEC 60068-1, subclause 5.3. Unless otherwise specified, the following value supplied

Temperature: 15 °C to 35 °C. Relative humidity: 45% to 75%.

Air pressure: 86kPa to 106 kPa (860 mbar to 1060 mbar).

All soldering tests are performed with mildly activated flux.

**THICK FILM CHIP RESISTORS 0201 SERIES**
**TEST METHOD AND REQUIREMENT**

TEST	PROCEDURE / TEST METHOD	REQUIREMENT	
		Resistor	Ω
<b>Electrical Characteristics</b> <b>JISC5201-1: 1998</b> <b>Clause 4.8</b>	- DC resistance values measurement - Temperature Coefficient of Resistance (T.C.R) Natural resistance change per change in degree centigrade. $\frac{R_2 - R_1}{R_1(t_2 - t_1)} \times 10^6 \text{ (ppm/}^\circ\text{C)} \quad t_1 : 20^\circ\text{C}+5^\circ\text{C}-1^\circ\text{C}$ R1 : Resistance at reference temperature (20°C+5°C/-1°C) R2 : Resistance at test temperature (-55°C or +125°C)	Within the specified tolerance.  Refer to "QUICK REFERENCE DATA"	<50mΩ
<b>Short time overload (S.T.O.L)</b> <b>Clause 4.13</b>	Permanent resistance change after a 5 sec. application of a voltage 2.5 times RCWV or the Max. overload voltage specified in the above list, whichever is less	ΔR/R Max. +/- (2%+0.10Ω)	<50mΩ
<b>Resistance to soldering heat(R.S.H)</b> <b>JISC5201-1:1998</b> <b>Clause 4.18</b>	Un-mounted chips completely immersed for 10±1 second in a SAC solder bath at 260°C±5°C	5%: ΔR/Rmax. ± (1%+0.05Ω) no visible damage	<50mΩ
<b>Solderability</b> <b>JISC5201-1: 1998</b> <b>Clause 4.17</b>	Un-mounted chips completely immersed for 2±0.5 second in a SAC solder bath at 235°C±5°C	95% coverage min., good tinning and no visible damage	
<b>Temperature cycling</b> <b>JISC5201-1: 1998</b> <b>Clause 4.19</b>	30 minutes at -55°C±3°C, 2~3 minutes at 20°C+5°C-1°C, 30 minutes at +155° C±3°C, 2~3 minutes at 20°C+5°C-1°C, total 5 continuous cycles	ΔR/Rmax. ± (1%+0.05Ω) no visible damage	<50mΩ
<b>Bending strength</b> <b>JISC5201-1: 1998</b> <b>Clause 4.33</b>	Resistors mounted on a 90mm glass epoxy resin PCB(FR4), bending once 3mm for 10sec, 5mm for CR02	ΔR/Rmax. ± (1%+0.05Ω) no visible damage	<50mΩ

**THICK FILM CHIP RESISTORS 0201 SERIES**

**TEST METHOD AND REQUIREMENT**

TEST	PROCEDURE / TEST METHOD	REQUIREMENT	
		Resistor	0Ω
<b>Adhesion</b> <b>JISC5201-1: 1998</b> <b>Clause 4.32</b>	Pressurizing force: .3N, Test time: 10±1sec.	No remarkable damage or removal of the terminations	
<b>Load life in Humidity</b> <b>JISC5201-1: 1998</b> <b>Clause 4.24</b>	1000 +48/-0 hours, loaded with RCWV or Vmax in humidity chamber controller at 40°C±2°C and 90~95% relative humidity, 1.5hours on and 0.5 hours off	$10\Omega \leq R < 1\text{ M}\Omega$ $\Delta R/R \text{ Max. } +/- (3\% + 0.10\Omega)$ $1\text{ M}\Omega \leq R < 10\Omega$ $\Delta R/R \text{ Max. } +/- (5\% + 0.10\Omega)$	$< 50\text{m}\Omega$
<b>Load life (endurance)</b> <b>JISC5201-1: 1998</b> <b>Clause 4.25</b>	1000 +48/-0 hours, loaded with RCWV or Vmax in chamber controller 70±2°C, 1.5 hours on and 0.5 hours off	Ditto	



**THICK FILM CHIP RESISTORS 0201 SERIES**

**REEL DIMENSION (Unit: mm)**

7": 15,000Ppcs/Reel

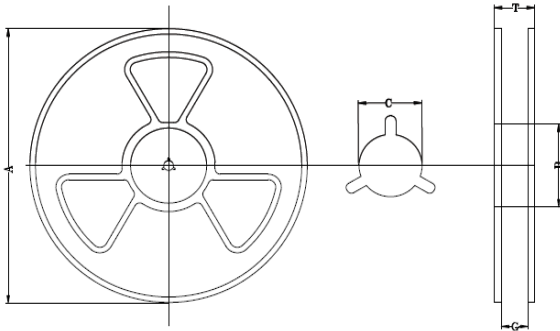

Code	Dimension 7"	Dimension 10"	Dimension 13"
A	<b>178.0+/-2.0</b>	254.0+/-2.0	330.0+/-2.0
B	<b>60.0 +/-1.0</b>	100 +/-1.0	100+/-1.0
C	<b>13.0+/-0.20</b>	13.0+/-0.20	13.0+/-0.20
T	<b>9.0+/-0.50</b>	9.0+/-0.5	9.0+/-0.5

**TAPE DIMENSION (Unit: mm)**

Paper Tape

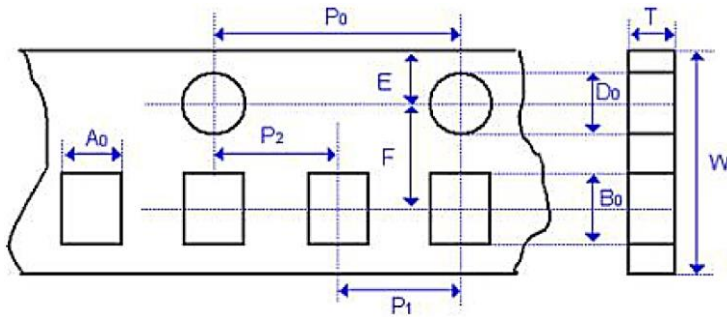

Code	Dimension
A 0	0.37+/-0.05
B 0	0.67+/-0.05
T	0.45+/-0.05
W	8.00+/-0.20
P 0	4.00+/-0.05
10xP 0	40.0+/-0.20
P 1	2.00+/-0.05
P 2	-
D 0	1.50+/-0.10
E	1.75+/-0.10
F	3.50+/-0.05

**DISCLAIMER**

NextGen Component, Inc. reserves the right to make changes to the product(s) and or information contained herein without notice. No liability is assumed as a result of their use or application. No rights under any patent accompany the sale of any such product(s) or information