

Quartz Crystal

SMD-version

model	KX – 5T
frequency	24,5760 MHz
mode	fundamental
operating temperature	-40° ~ +85°C
frequency tolerance at +25°C	± 30 ppm
temperature tolerance -40° ~ +85°C	±100 ppm
load capacitance C_L	8 pF
series resonance R1 max.	100 Ohm
aging at +25°C (first year) max.	± 2 ppm
shunt capacitance C_0 max.	3,5 pF
drive level	50 μ W typ., 100 μ W max.
contents of reel	1000 pcs.
part no.	12.85538

Dimensions (mm):

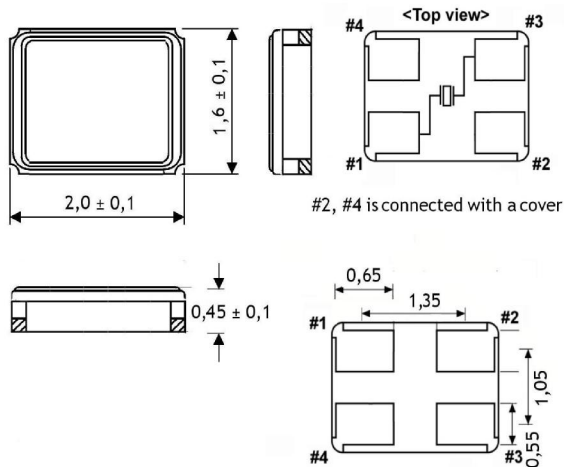

Reflow soldering condition:

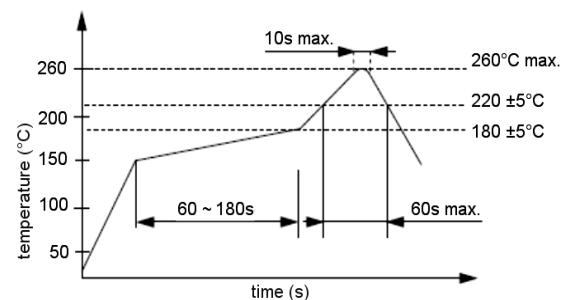

Suggested soldering pad:

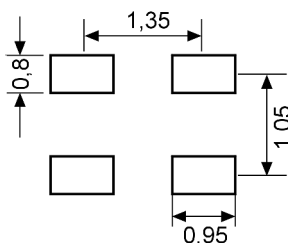

Tape specification:

